

Banco

B05



GIBAM

B05

Ogni progetto è unico. Attorno a questa idea è nato B05.

Un sistema componibile **altamente tecnologico**, concepito su principi di **semplicità e modularità**. Un prodotto pensato per accogliere **la più vasta gamma di accessori per il retail** presente sul mercato. Linee semplici e pulite, personalizzabili a 360° grazie ad una **esclusiva gamma di materiali**. Tutto questo è B05, perché voi ed il vostro negozio siete unici.

Every project is unique. Around this idea was born B05.

A high-tech modular system, devised on the principles of **simplicity and modularity**. A product designed to accommodate the **widest range of accessories for retail** on the market. Simple, clean lines, customizable 360 ° thanks to an **exclusive range of materials**. All this is B05, because you and your business are unique.

Il prodotto

Come è stato progettato [p.07](#) Come lo vede il cliente [p.09](#) Come lo vede l'operatore [p.11](#) Come comporre B05: la struttura [p.13](#) Come personalizzare B05: gli accessori [p.15](#)

Le applicazioni

Farmacia [p.19](#) Gioielleria [p.21](#) Abbigliamento [p.23](#) Ottica [p.25](#) Reception [p.27](#) Merceria [p.29](#) Libreria [p.31](#) Tabacchi [p.33](#) Fioreria [p.35](#) Elettronica [p.37](#)

The product

The way we designed it [p.07](#) The way the client sees it [p.09](#) The way the operator sees it [p.11](#) How to compose B05: the structure [p.13](#) How to "dress up" B05: the accessories [p.15](#)

The applications

Pharmacy [p.19](#) Jewellery [p.21](#) Fashion [p.23](#) Optical shop [p.25](#) Reception [p.27](#) Haberdashery [p.29](#) Bookstore [p.31](#) Tobacconist [p.33](#) Flower shop [p.35](#) Electronics [p.37](#)

Come è stato progettato. The way we designed it.

Robustezza Strength

Servizio clienti e zona cassa sono le aree più vissute in un punto vendita. Il banco B05 si distingue dagli standard di settore per le sue doti tecniche e l'elevata resistenza, rivoluzionando quindi il concetto di usura.

Inside a point of sale the most stressed area is that dedicated to customer service and cashier. The use of materials characterised by long durability puts B05 above the common standards, and makes a statement about the resistance to wear.

Funzionalità Functionality

B05 è stato studiato non solo come punto di appoggio o esposizione prodotti, ma come vero e proprio "centro nevralgico" all'interno del punto vendita. L'ampia gamma di accessori dedicata permette di configurare la zona retro banco secondo specifiche esigenze.

B05 has been devised not only as a place to put things down or as a showcase, but as a real center of relationship with the client. The product is furtherly completed by a large range of accessories and by the possibility to configure its back side in accordance to need.

Estetica Aesthetics

Il bello è funzionale. L'estetica minimale che caratterizza B05 si traduce in soluzioni semplici ed efficaci. L'estrema cura nella scelta dei materiali e delle superfici si traduce in un'esperienza piacevole alla vista e al tatto.

Beautiful and functional. The minimalistic aesthetics of B05 becomes simple and down-to-point solutions. Materials and surfaces chosen with great care create a pleasant visual and sensorial experience.

Convenienza Convenience

Tante idee per personalizzare B05. Una filosofia che permette di ottimizzare le risorse del retailer lasciando spazio solo a ciò che ritiene necessario. A questo si aggiunge la tecnologia LED che annulla quasi totalmente il concetto di "manutenzione" nel tempo e assicura un notevole risparmio dei consumi.

Many solutions from which to choose for the customization of B05. A philosophy that allows to optimize the resources of the retailer only taking what is necessary. To this we add the use of LED technology, that reduces to almost zero the need for maintenance over time, and becomes a money saver.



Come lo vede il cliente. The way the client sees it.

Esposizione

Vetrina ad angolo per l'esposizione di prodotti speciali.

Display solutions

Corner glass case for the display of special products.

Servizio e Assistenza

Bancalina in vetro satinato per il punto servizio/cassa.

Service and assistance

Frosted glass elevated top for the service/cashier desk.

Esposizione

Gradinale telefonica per l'esposizione "al tocco".

Display solutions

Step display for touchable mobile phones.

Esposizione

Esposizione verticale multifunzionale.

Display solutions

Vertical display.

Comunicazione

Fronte stampato con grafica personalizzata.

Communication

Printed front with thematic prints.

Servizio e Assistenza

Ripiano luminoso poggia borse.

Service and assistance

Lit shelf for bags.

Comunicazione

Box luminoso per la comunicazione.

Communication

Communication box with light.

Come lo vede l'operatore. The way the operator sees it.

Organizzazione
Cassettiera.

Organization
Chest of drawers.

Esposizione

Esposizione verticale
multifunzionale.

Display solutions

Multifunctional vertical
display panel.

**Servizio e
Assistenza**

Bancalina in vetro
satinato per il punto
servizio/cassa.

**Service and
assistance**

Frosted glass front top
for the service/cashier
area.

Esposizione

Vetrina espositiva con
illuminazione.

Display solutions

Display glass case with
light.

**Servizio e
Assistenza**

Volume di assistenza e
scrivania.

**Service and
assistance**

Assistance and general
desk unit.

Organizzazione
Ripiano a giorno porta
stampante.

Organization
Printer shelf.

Organizzazione

Contenitore porta buste
in plexiglas opale.

Organization

Bag container in milky
acrylic.

Organizzazione

Contenitore grucce.

Organization

Space for hanging
clothes in milky acrylic.

Organizzazione

Vano multifunzionale con
ante.

Organization

Multifunctional cabinet.

Il Top

Il Top, attrezzato con o senza foro passacavo, è disponibile in una vastissima gamma di materiali.

The Top

The desk top surface, available with or without cable hole, can be produced in a very large range of materials.

La scocca

Attraverso l'unione del volume dritto e degli angoli interni ed esterni è possibile sviluppare ogni forma di layout.

The Body

The combination of the straight unit and of internal and external corners allows to develop many different shapes.

Il Frontale

Frontale e Top si abbinano perfettamente e prevedono entrambi la stampa digitale con grafica personalizzata.

The Front Panel

The Front Panel continues the top surface and can be customised also with printed materials from pictures.

Lo zoccolo

Lo Zoccolo, in plastica pvc disponibile nel colore bianco o nero, si abbina perfettamente alla struttura ed è facile da pulire.

The Skirting Board

The Skirting Board, made of PVC, available in white or black colours, perfectly matches the structures and it's easy to clean.

Il Fianco

I due Fianchi laterali terminano la composizione e si abbinano alla Scocca e allo Zoccolo.

The Side

The two sides end the product and are harmonised in finish with the body and the skirting board.

Come comporre B05: la struttura.

How to compose B05: the structure.

Tutto quello che vuoi con la massima semplicità. Abbiamo disegnato un sistema semplice e veloce da progettare, per permettervi di gestire anche le soluzioni più complesse in termini di gestione dello spazio. Un unico modulo in due altezze combinabili tra loro permettono di moltiplicare le soluzioni funzionali a disposizione del progettista. I rivestimenti, in vetro, legno e materiali compositi possono essere applicati a qualsiasi soluzione di layout.

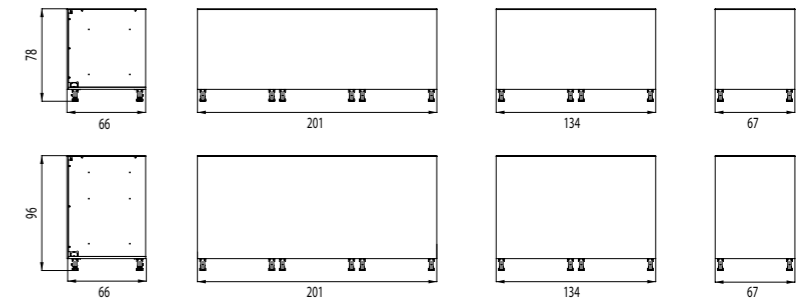

Possibili combinazioni:

Possible combinations:

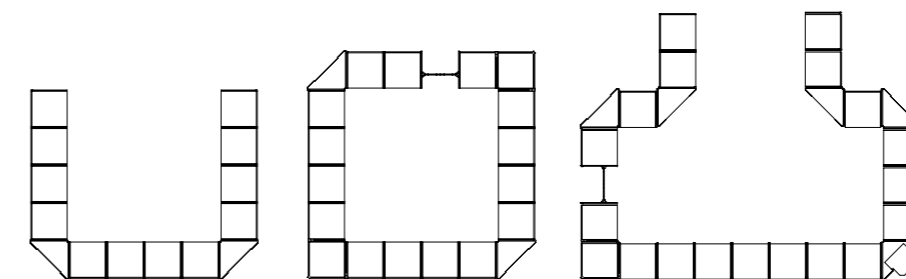
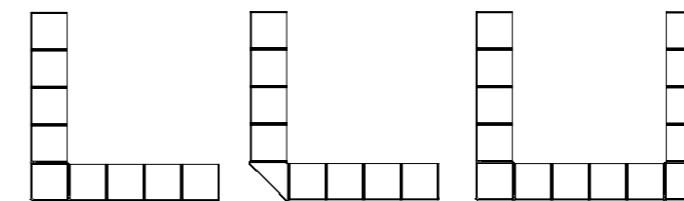
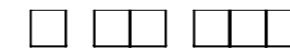

Everything you may want with the greatest simplicity. We have designed a system that is simple yet quick to be used, suitable to be applied to the most complex situations of space management. One module presented with two combinable heights that allow to create multiple functional solutions. The various surface finishing materials, as glass, wood and composites can be used in every layout solution.

Esposizione

Vetrine, gradinali al "tocco", ripiani, ecc. presentano il prodotto al meglio, trasformando il banco in un valido sistema espositivo.

Display solutions

Glass cases, step display elements for touchable products, shelves give visibility to the products and transform the counter in a valid display system.



Servizio

Gli accessori che completano le aree dedicate alla vendita assistita sono pensati per garantire il massimo comfort all'operatore e al cliente.

Service

The accessories that complete the areas dedicated to assisted sale are devised to guarantee maximum comfort to both operator and client.

Organizzazione

Cassetiera, ripiano porta tastiera, vano porta buste, sono solo alcuni degli accessori pensati per agevolare al meglio l'operatore nell'organizzazione del proprio spazio lavoro.

Organization

Chest of drawers, keyboard support, bags container, are just some of the accessories created for the operator and aimed at organise the working space.



Come personalizzare B05: gli accessori.

How to "dress" B05: the accessories.

B05 è il luogo in cui si incontrano gli aspetti legati alla gestione del punto vendita e quelli più vicini al rapporto con il cliente. Un' efficace strumento di lavoro. Una eccezionale gamma di accessori, pensati attorno a chi lavora ed alle sue esigenze specifiche, permette di attrezzare un banco altamente funzionale e professionale. La qualità dei materiali e delle finiture, la chiarezza espositiva e di servizio garantiti da B05, contribuiscono nel rinforzare la vostra immagine di retailer agli occhi dei clienti.

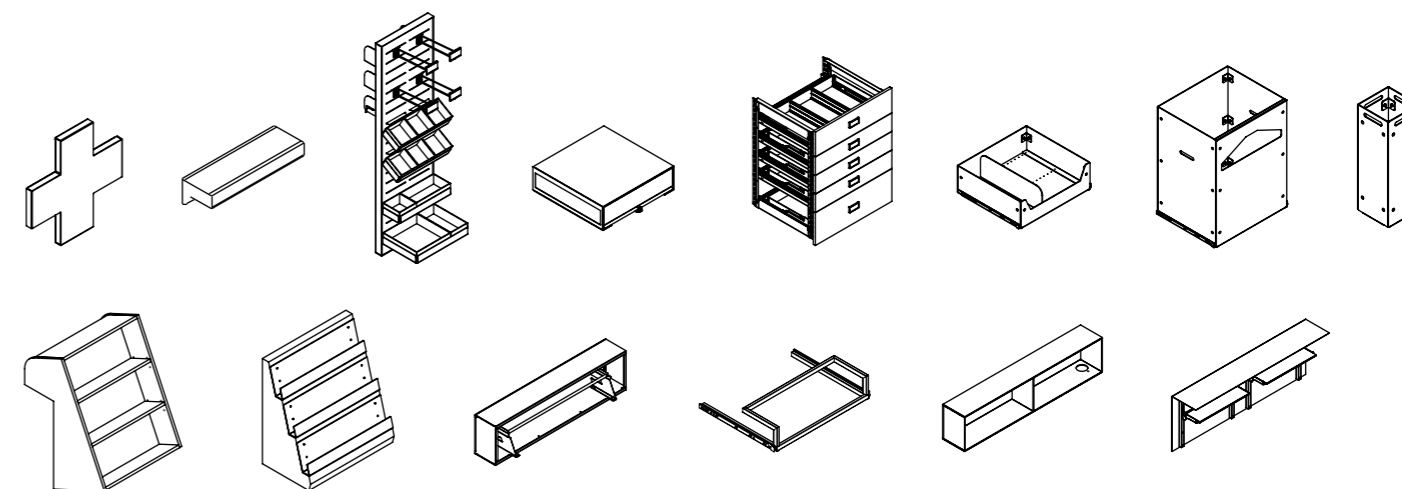
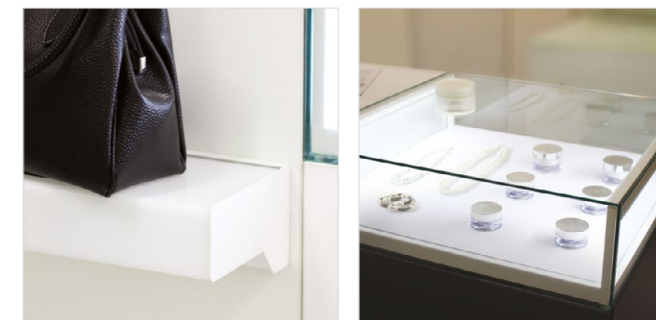

B05 is the place where the aspects related to the management of the store and the ones closest to the customer relationship meet. An effective working tool. An exceptional range of accessories designed around the people who work and its needs, allows you to equip a counter highly functional and professional. The quality of materials and finishes, the clarity of the displays and of the service guaranteed service by B05, help in reinforcing your image as a retailer in the eyes of clients.

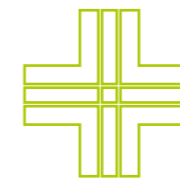

Farmacia
Pharmacy

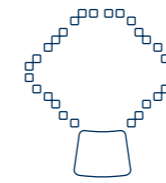

Gioielleria
Jewellery



Abbigliamento
Fashion



Ottica
Optical shops



Reception
Reception



Merceria
Haberdashery



Libreria
Bookstore

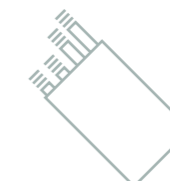

Tabacchi
Tobacconist



Fioreria
Flower shop



Elettronica
Electronics

Total white e legno per la farmacia.

Full white and wood for the pharmacy.



1. Insegna farmacia luminosa.
2. Cassettiera generica.
3. Cassettiera farmacia.
4. Espositore verticale - Lato cliente.
5. Espositore verticale - Lato operatore.
6. Vetrina bassa.
7. Poggiaborse.

1. Pharmacy lit sign.
2. Chest of drawer.
3. Pharmacy chest of drawers.
4. Vertical display panel - Client side.
5. Vertical display panel - Operator side.
6. Low glass case.
7. Bags holder.

 "Studiati per"
 "Devised for"



Insegna farmacia luminosa
Pharmacy lit sign



Poggiaborse
Bags holder



Espositore verticale
Vertical display panel

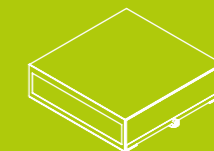

Vetrina bassa
Low glass case



Cassettiera farmacia
Pharmacy chest of drawers

*Attenzione: l'elenco sopra è puramente indicativo, gli accessori possono essere utilizzati per più categorie merceologiche.
*Warning: The above list is only indicative, the accessories can be used for more than one category.

Deluxe futurista per l'esposizione gioielli.

Futuristic touch for jewels display.



1.2.3. Vetrina bassa.
4. Cassetto cassa.
5. Contenitore buste.

1.2.3. Low glass case.
4. Cash drawer.
5. Bags holder box.

 "Studiati per"
"Devised for"



Vetrina alta
High glass case



Vetrina bassa
Low glass case

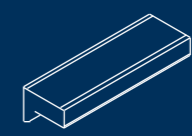

Poggiaborse
Bags holder



Cassetto cassa
Cash drawer

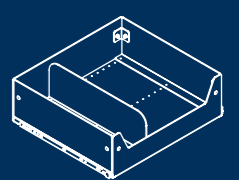

Contenitore buste
Bags holder box

*Attenzione: l'elenco sopra è puramente indicativo, gli accessori possono essere utilizzati per più categorie merceologiche.
*Warning: The above list is only indicative, the accessories can be used for more than one category.

Denim Style con top retro stampato per l'abbigliamento.

Denim Style and back-printed top for the fashion shop.



1. Cassetto cassa.
2. Tiretto tastiera pc.
3. Contenitore buste.
4. Gancera sottopiano scorrevole.
5. Contenitore grucce scorrevole.
6. Contenitore antitaccheggio/umido.

1. Cash drawer.
2. Pc keyboard sliding shelf.
3. Bags holder box.
4. Undertop sliding hook rack.
5. Sliding hangers holder.
6. Box for anti-theft tags/trash.



"Studiati per"
"Devised for"

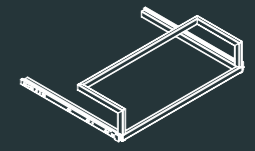

Gancera sottopiano scorrevole
Undertop sliding hook rack

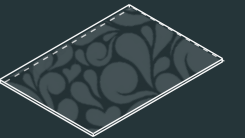

Top retro stampato
Back-printed top



Cassetto cassa
Cash drawer

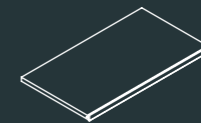

Tiretto tastiera pc
Pc keyboard sliding shelf

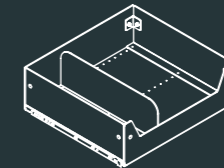

Contenitore buste
Bags holder box



Contenitore grucce scorrevole
Sliding hangers holder



Contenitore antitaccheggio/umido
Sliding hangers holder

*Attenzione: l'elenco sopra è puramente indicativo, gli accessori possono essere utilizzati per più categorie merceologiche.
*Warning: The above list is only indicative, the accessories can be used for more than one category.

Industrial trends per l'arredo ottica.

Industrial trends for optical shops.



opti



1.2.3. Vetrina bassa e gradinale porta occhiali.
4. Volume angolare top, frontale e fianco.
5. Bancalina frontale chiusa.

1.2.3. Low glass case and glasses step holder.
4. Outer corner top, front panel and side panel.
5. Glass front raised top.

"Studiati per"
"Devised for"



Bancalina frontale chiusa
Glass front raised top

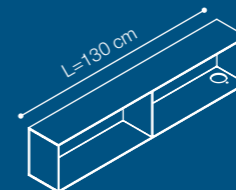

Bancalina frontale chiusa
Glass front raised top



Vetrina alta
High glass case

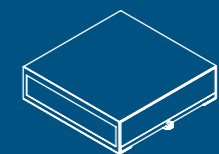

Vetrina bassa
Low glass case

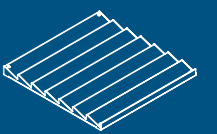

Gradinale portaocchiali
Glasses step holder

*Attenzione: l'elenco sopra è puramente indicativo, gli accessori possono essere utilizzati per più categorie merceologiche.
*Warning: The above list is only indicative, the accessories can be used for more than one category.

"Less is more" per l'area reception.

"Less is more" for the reception area.



- 1. Bancalina frontale.
- 2. Volume angolare top, frontale e fianco.
- 3. Tiretto tastiera pc.
- 4.5. Top volume diritto con passacavo.
- 6. Cassettiera generica.
- 7. Poggiaborse.

- 1. Front raised top.
- 2. Outer corner top, front panel and side panel.
- 3. Pc keyboard sliding shelf.
- 4.5. Straight element cable hole top cover.
- 6. Chest of drawer.
- 7. Bags holder.

"Studiati per"
"Devised for"



Bancalina frontale
Front raised top

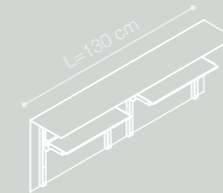

Bancalina frontale
Front raised top



Tiretto tastiera pc
Pc keyboard sliding shelf

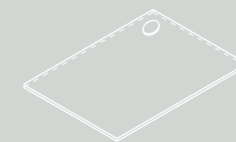

Top volume diritto con passacavo
Straight element cable hole top cover



Cassettiera generica
Chest of drawer

Ambiente caldo e accogliente per la merceria. Warm and welcoming environment for the haberdashery.



1.2.3. Vetrina bassa.
4. Zoccolo lineare.
5. Top retro stampato.

1.2.3. Low glass case.
4. Linear skirting.
5. Back-printed top.



Vetrina alta
High glass case



Vetrina bassa
Low glass case



Cassetto cassa
Cash drawer

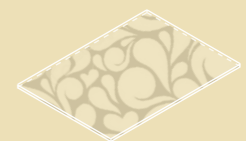

Top retro stampato*
Back-printed top*

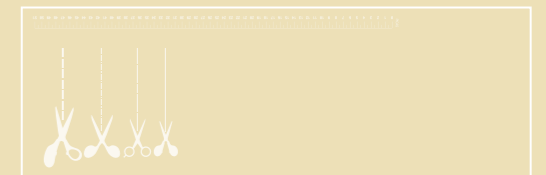

* L'utilizzo del top retro stampato permette di caratterizzare il punto vendita con grafiche "a tema". Nel caso di questa merceria, per esempio, abbiamo integrato il metro sul piano lavoro.

* The use of the back-printed top allows to give character to the point of sale with thematic prints. In this example we have integrated the meter picture on the working surface.

*Attenzione: l'elenco sopra è puramente indicativo, gli accessori possono essere utilizzati per più categorie merceologiche.
*Warning: The above list is only indicative, the accessories can be used for more than one category.

Pattern decorativo per il negozio di libri.

Decorative pattern for the bookstore.



1.2.3. Espositore libri.
4. Cassettiera generica.
5.6. Portariviste.
7. Contenitore buste.
8. Cassettiera generica.

1.2.3. Books holder.
4. Chest of drawer.
5.6. Magazine holder.
7. Bags holder box.
8. Chest of drawer



Cassettiera generica
Chest of drawer

"Studiati per"
"Devised for"

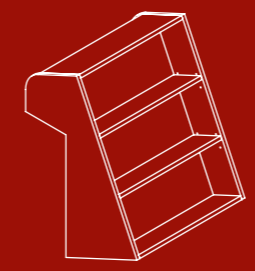

Espositore libri
Books holder

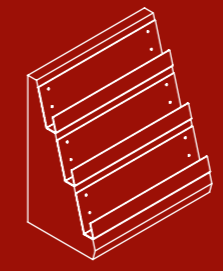

Portariviste inferiore
Lower magazine holder



Portariviste superiore
Upper magazine holder



Cassetto cassa
Cash drawer

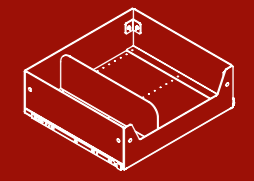

Contenitore buste
Bags holder box

*Attenzione: l'elenco sopra è puramente indicativo, gli accessori possono essere utilizzati per più categorie merceologiche.
*Warning: The above list is only indicative, the accessories can be used for more than one category.

Atmosfera classica ed elegante per il tabacchi. Classical and elegant atmosphere for the tobacconist.



1.2.3. Vetrina bassa.
4.5. Vetrina sigari.
6. Ripiano spingi-pacchetto sigarette.

1.2.3. Low glass case.
4.5. Cigars humidor.
6. Cigarettes packet push-shelf.

"Studiati per"
"Devised for"

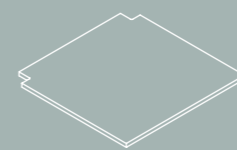

Ripiano
Shelf

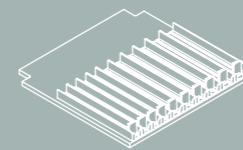

Ripiano spingi-pacchetto sigarette
Cigarettes packet push-shelf



Vetrina sigari
Cigars humidor

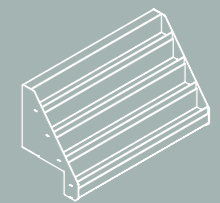

Gradinale portacaramelle
Candies holder

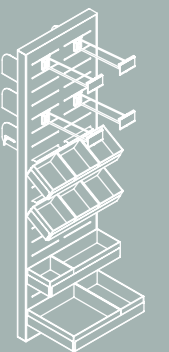

Espositore verticale
Vertical display panel

*Attenzione: l'elenco sopra è puramente indicativo, gli accessori possono essere utilizzati per più categorie merceologiche.
*Warning: The above list is only indicative, the accessories can be used for more than one category.

Massima funzionalità per il negozio di fiori.

Maximum functionality for the flower shop.



1. Portartolo per espositore.
2. Taglierina carta regalo.
3. Contenitore buste.
4. Contenitore antitaccheggio/umido.
5. Cassetto cassa.
6. Cassettiera generica.

1. Display panel roll holder.
2. Wrapping paper cutter.
3. Bags holder box.
4. Box for anti-theft tags/trash.
5. Cash drawer.
6. Chest of drawer.



"Studiati per"
"Devised for"

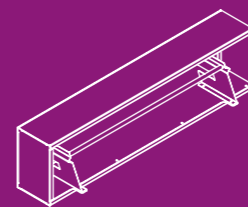

Taglierina carta regalo
Wrapping paper cutter

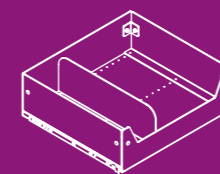

Contenitore buste
Bags holder box



Contenitore
antitaccheggio/umido
Box for anti-theft tags/trash



Cassetto cassa
Cash drawer



Cassettiera generica
Chest of drawer

*Attenzione: l'elenco sopra è puramente indicativo, gli accessori possono essere utilizzati per più categorie merceologiche.
*Warning: The above list is only indicative, the accessories can be used for more than one category.

"Dark cybernetic" per il mondo elettronica.

"Dark cybernetic" for the electronics world.

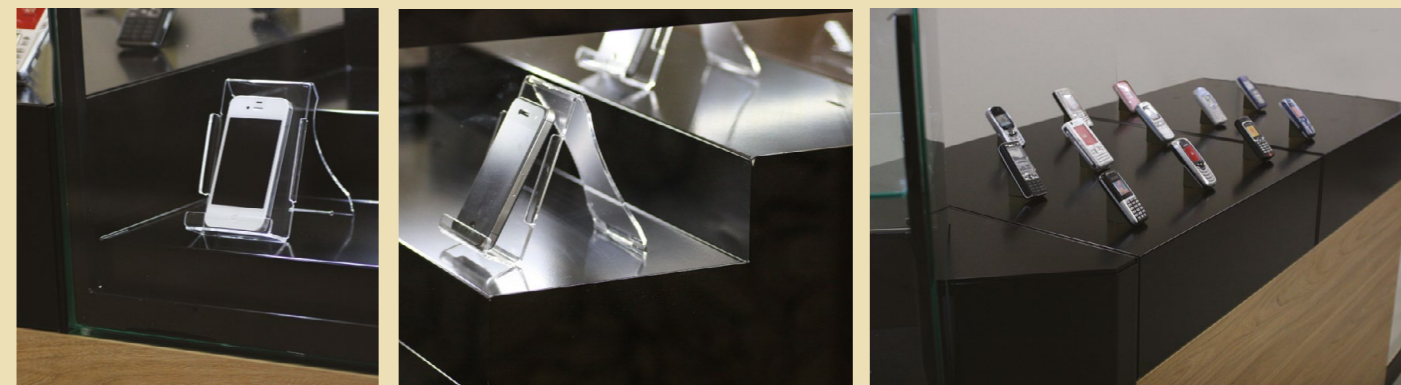

1.2. Gradinale interno.
3. Espositore al tocco.
4. Gradinale al tocco.
5.6. Vetrina angolo alta.

1.2. Encased step open display.
3. Flat open display.
4. Step open display.
5.6. Corner high glass case.



"Studiati per"
"Devised for"

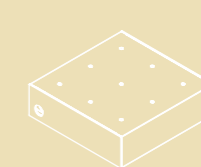

Espositore al tocco
Flat open display

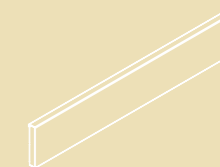

Insegna luminosa
Blacklit signage holder



Vetrina alta
High glass case



Vetrina bassa
Low glass case



Vetrina angolo alta
Corner high glass case

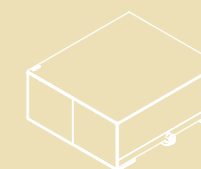

Vetrina angolo bassa
Corner low glass case



Gradinale al tocco
Step open display

*Attenzione: l'elenco sopra è puramente indicativo, gli accessori possono essere utilizzati per più categorie merceologiche.
*Warning: The above list is only indicative, the accessories can be used for more than one category.

Banco

B05

stampato in Italia
printed in Italy

© GIBAM SHOPS spa - unipersonale

Ottobre 2023
October 2023

direzione artistica Anidride Design
art direction Anidride Design

design di Nicola De Pellegrini - Anidride Design
design by Nicola De Pellegrini - Anidride Design

render Alessandro Pregolato
render Alessandro Pregolato

è vietata la riproduzione totale o parziale del catalogo
senza previa autorizzazione di Gibam Shops spa - unipersonale.
this catalogue cannot be partially or totally reproduced unless
Gibam Shops spa - unipersonale has granted permission to do so.



GIBAM SHOPS spa - unipersonale

Via VIII Strada, 13
61032 Bellocchi di Fano (PU) ITALIA
tel. +39 0721 85991

www.gibam.it
www.gibamcomposit.com
staff@gibam.it

X0NCFB05